



ALPINE®

EN

CDA-7892E

FM/AM CD Receiver

- OWNER'S MANUAL
Please read before using this equipment.

ALPINE ELECTRONICS, INC.

Tokyo office: 1-1-8 Nishi Gotanda,
Shinagawa-ku,
Tokyo 141-8501, Japan
Tel.: (03) 3494-1101

ALPINE ELECTRONICS OF AMERICA, INC.

19145 Gramercy Place, Torrance,
California 90501, U.S.A.
Tel.: 1-800-ALPINE-1 (1-800-257-4631)

ALPINE ELECTRONICS OF CANADA, INC.

Suite 203, 7300 Warden Ave. Markham,
Ontario L3R 9Z6, Canada
Tel.: 1-800-ALPINE-1 (1-800-257-4631)

ALPINE ELECTRONICS OF AUSTRALIA PTY. LTD.

6-8 Fiveways Boulevard Keysborough,
Victoria 3173, Australia
Tel.: (03) 9769-0000

ALPINE ELECTRONICS GmbH

Kreuzerkamp 7-11 40878 Ratingen, Germany
Tel.: 02102-45 50

ALPINE ITALIA S.p.A.

Via C. Colombo 8, 20090 Trezzano Sul Naviglio
MI, Italy
Tel.: 02-48 47 81

ALPINE ELECTRONICS FRANCE S.A.R.L.

(RCS PONTOISE B 338 101 280)
98, Rue De La Belle Etoile, Z.I. Paris Nord II
B.P. 50016 F-95945, Roissy, Charles De Gaulle
Cedex, France
Tel.: 01-48 63 89 89

ALPINE ELECTRONICS OF U.K., LTD.

13 Tanners Drive, Blakelands, Milton Keynes
MK14 5BU, U.K.
Tel.: 01908-61 15 56

ALPINE ELECTRONICS DE ESPAÑA, S.A.

Portal De Gamarra 36, Pabellón 32
01013 Vitoria (Alava)-Apdo. 133, Spain
Tel.: 34-45-283588

Melyi Printing Factory, Dalian, China
No. 28 Chang Qing Street, XI Gang District, Dalian, China

Designed by ALPINE Japan
Printed in China (Y)
68P02294K02-A

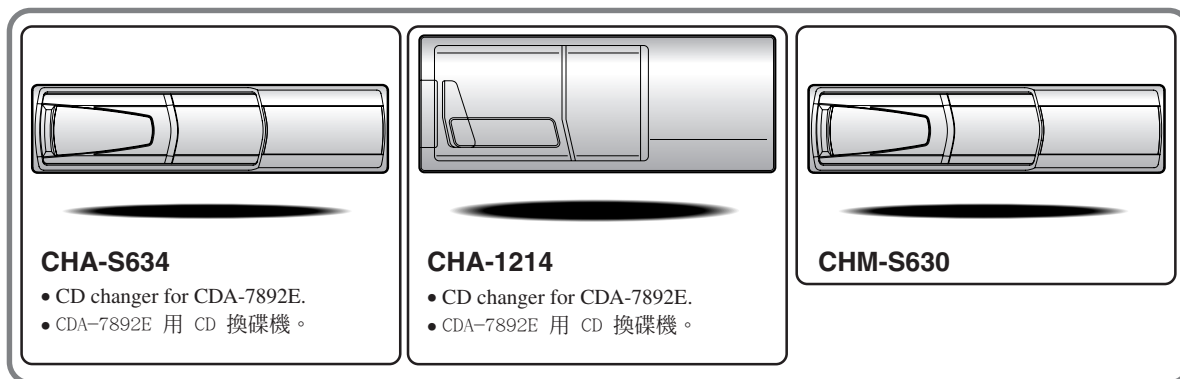

Alpine CD Changers Give You More!

More musical selections, more versatility, more convenience.

The CHA-S634 is a high-performance 6-disc changer with a new M DAC, CD-R/RW PLAY BACK, MP3 PLAY BACK and CD TEXT. The CHA-1214 Ai-NET model holds 12 discs, and the CHM-S630 M-Bus model is a super-compact 6-disc changer with a CD-R/RW PLAY BACK.

Alpine CD 換碟器讓您更加滿意！

更多音樂選項，更多功能性，更佳方便性。

CHA-S634 是一個帶新型 M DAC，CD-R/RW PLAY BACK，MP3 PLAY BACK 和 CD TEXT 的高性能 6 碟式換碟器。CHA-1214 Ai-NET 型號可裝載 12 張唱碟，CHM-S630 M-Bus 型號是一個帶 CD-R/RW PLAY BACK 的超小型 6 碟式換碟器。

Contents

Operating Instructions



WARNING

WARNING	2
CAUTION	2
PRECAUTIONS	2



Basic Operation

Detaching the Front Panel	4
Attaching the Front Panel	4
Initial System Start-Up	4
Turning Power On and Off	4
Display Angle Adjustment	5
Adjusting Volume/Balance (Between Left and Right)/Fader (Between Front and Rear)/Defeat	5
Audio Mute Function	5
Displaying Time	5
Setting Time	5
Setting the Bass Control	6
Setting the Treble Control	6
Adjusting the built-in Crossover	6
About the Time Correction	7
Bass Focus	8
Time Correction	9
Setting the MX Mode	9
Quick Searching Function	10
Changing the Audio Level Display ON/OFF	10
Displaying the Title/Text	10
Titling Discs/Stations	11
Erasing Disc Title/Station Title	11

SETUP Operation

Switching the Tuner Mode	12
Subwoofer On and Off	12
Sound (Beep) Guide Function	12
Turning Mute Mode On/Off	13
Scroll Setting	13
Setting the AUX Mode (V-Link)	13
Connecting to an External Amplifier	14
Setting the Defeat of the External Input	15
Demonstration	15

Radio Operation

Manual Tuning	16
Automatic Seek Tuning	16
Manual Storing of Station Presets	17
Automatic Memory of Station Presets	17
Tuning to Preset Stations	17

CD Player Operation

Opening and Closing the Movable display	18
Playback	18
Music Sensor (Skip)	19
Fast Forward and Backward	19
Repeat Play	19
M.I.X. (Random Play)	19
Scanning Programmes	19
Controlling CD Changer (Optional)	20
Multi-Changer Selection	20

MP3 Changer Operation (Optional)

Playing MP3 Files	21
Music Sensor (Skip)	21
Fast Forward and Backward	21
Selecting Folders	21
File Search	21
Repeat Play	21
M.I.X. (Random Play)	22
Scanning Programmes	22
Setting the Range of MP3 File Selection	22
Playing MP3 Data	22

Information

In Case of Difficulty	23
Specifications	25

Installation and Connections

Warning	26
Caution	26
Precautions	26
Installation	27
Connections	28

WARNING

WARNING

This symbol means important instructions. Failure to heed them can result in serious injury or death.

DO NOT OPERATE ANY FUNCTION THAT TAKES YOUR ATTENTION AWAY FROM SAFELY DRIVING YOUR VEHICLE.

Any function that requires your prolonged attention should only be performed after coming to a complete stop. Always stop the vehicle in a safe location before performing these functions. Failure to do so may result in an accident.

KEEP THE VOLUME AT A LEVEL WHERE YOU CAN STILL HEAR OUTSIDE NOISE WHILE DRIVING.

Failure to do so may result in an accident.

DO NOT DISASSEMBLE OR ALTER.

Doing so may result in an accident, fire or electric shock.

USE ONLY IN CARS WITH A 12 VOLT NEGATIVE GROUND.

(Check with your dealer if you are not sure.) Failure to do so may result in fire, etc.

KEEP SMALL OBJECTS SUCH AS BATTERIES OUT OF THE REACH OF CHILDREN.

Swallowing them may result in serious injury. If swallowed, consult a physician immediately.

USE THE CORRECT AMPERE RATING WHEN REPLACING FUSES.

Failure to do so may result in fire or electric shock.

DO NOT BLOCK VENTS OR RADIATOR PANELS.

Doing so may cause heat to build up inside and may result in fire.

USE THIS PRODUCT FOR MOBILE 12V APPLICATIONS.

Use for other than its designed application may result in fire, electric shock or other injury.

DO NOT PLACE HANDS, FINGERS OR FOREIGN OBJECTS IN INSERTION SLOTS OR GAPS.

Doing so may result in personal injury or damage to the product.

CAUTION

This symbol means important instructions. Failure to heed them can result in injury or material property damage.

HALT USE IMMEDIATELY IF A PROBLEM APPEARS.

Failure to do so may cause personal injury or damage to the product. Return it to your authorized Alpine dealer or the nearest Alpine Service Center for repairing.

KEEP FINGERS AWAY WHILE THE MOTORIZED FRONT PANEL OR MOVING MONITOR IS IN MOTION.

Failure to do so may result in personal injury or damage to the product.

PRECAUTIONS

Temperature

Be sure the temperature inside the vehicle is between +60°C (+140°F) and -10°C (+14°F) before turning your unit on.

Moisture Condensation

You may notice the CD playback sound wavering due to condensation. If this happens, remove the disc from the player and wait about an hour for the moisture to evaporate.

Damaged Disc

Do not attempt to play cracked, warped, or damaged discs. Playing a bad disc could severely damage the playback mechanism.

Maintenance

If you have problems, do not attempt to repair the unit yourself. Return it to your Alpine dealer or the nearest Alpine Service Station for servicing.

Never Attempt the Following

Do not grip or pull out the disc while it is being pulled back into the player by the automatic reloading mechanism.

Do not attempt to insert a disc into the unit when the unit power is off.

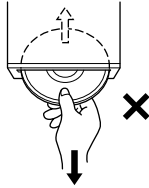

Inserting Discs

Your player accepts only one disc at a time for playback. Do not attempt to load more than one disc.

Make sure the label side is facing up when you insert the disc. Your player will automatically eject any disc that is inserted incorrectly. If the player continues to eject a correctly inserted disc, push the RESET switch with a pointed object such as a ballpoint pen.

Playing a disc while driving on a very bumpy road may result in skips, but this will not scratch the disc or damage the player.

New Discs

As a protective measure to prevent the CD from jamming, the CD player will automatically eject discs with irregular surfaces or inserted incorrectly. When a new disc is inserted into the player and ejected after initial loading, using your finger, feel around the inside of the centre hole and outside edge of the disc. If you feel any small bumps or irregularities, this could inhibit proper loading of the disc. To remove the bumps, rub the inside edge of the hole and outside edge of the disc with a ballpoint pen or other such instrument, then insert the disc again.

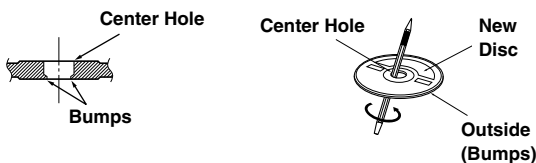

Irregular Shaped Discs

Be sure to use round shape discs only for this unit and never use any special shape discs.

Use of special shape discs may cause damage to the mechanism.

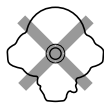

Installation Location

Make sure the CDA-7892E will not be installed in a location subjected to:

- Direct sun and heat
- High humidity and water
- Excessive dust
- Excessive vibrations

Correct Handling

Do not drop the disc while handling. Hold the disc so you will not leave fingerprints on the surface. Do not affix tape, paper, or gummed labels to the disc. Do not write on the disc.

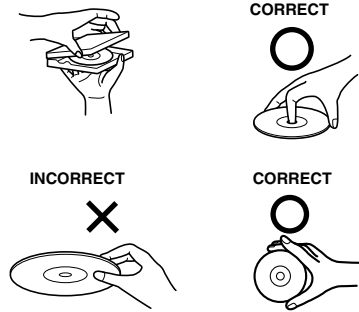

Disc Cleaning

Fingerprints, dust, or soil on the surface of the disc could cause the CD player to skip. For routine cleaning, wipe the playing surface with a clean, soft cloth from the centre of the disc to the outer edge. If the surface is heavily soiled, dampen a clean, soft cloth in a solution of mild neutral detergent before cleaning the disc.



Disc Accessories

There are various accessories available on the market for protecting the disc surface and improving sound quality. However, most of them will influence the thickness and/or diameter of the disc. Using such accessories can cause the disc to be out of standard specifications and may create operational problems. We recommend not using these accessories on discs played in Alpine CD players.

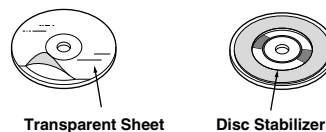

Basic Operation

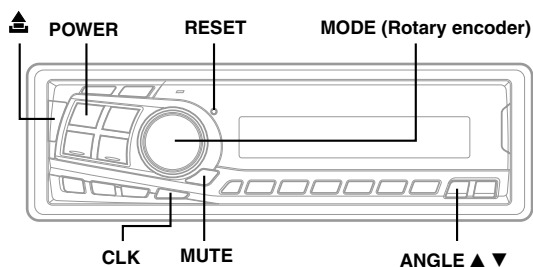

- **Controllable with Remote Control**
This unit can be controlled with an optional Alpine remote control. For details, consult your Alpine dealer.
- Point the optional remote control transmitter at the remote control sensor.

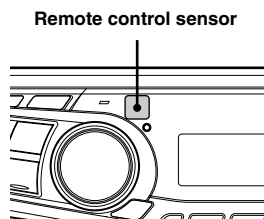

Detaching the Front Panel

- 1 Press and hold the **POWER** button for more than 3 seconds to turn off the power.
- 2 Press the ▲ (Release) button at left side until the front panel pops out.
- 3 Grasp the left side of the front panel and pull it out.

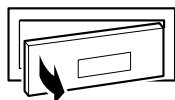

NOTES

- The front panel may become hot in normal usage (especially the connector terminals on the back of the front panel.) This is not a malfunction.
- To protect the front panel, place it in the supplied carrying case.

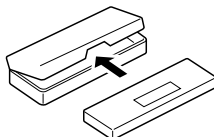

Attaching the Front Panel

- 1 First, insert the right side of the front panel into the main unit. Align the groove on the front panel with the projections on the main unit.
- 2 Push the left side of the front panel until it locks firmly into the main unit.

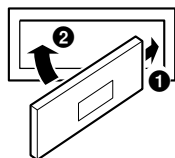

NOTES

- Before attaching the front panel, make sure that there is no dirt or dust on the connector terminals and no foreign object between the front panel and the main unit.
- Attaching the front panel carefully, holding the sides of the front panel to avoid pushing buttons by mistake.

Initial System Start-Up

Be sure to press the **RESET** switch when using the unit for the first time, after installing the CD changer, etc., or after changing the car battery.

- 1 Make sure that the power of the unit is off. If the is on, press and hold the **POWER** button for at least 3 seconds to turn off the unit.
- 2 Press the **RESET** switch with a ballpoint pen, or any other pointed object.



Turning Power On and Off

- 1 Press the **POWER** button to turn on the unit.

NOTE

The unit can be turned on by pressing any other button except the eject ▲ and CLK/TITLE buttons.

The volume level gradually increases to the previous level you were listening to before the unit was turned off. Press and hold the **POWER** button for at least 3 seconds to turn off the unit.

NOTE

The first time power is turned on, the volume will start from level 12.

Display Angle Adjustment

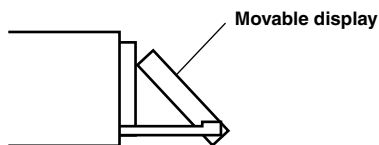

The movable display may be adjusted to 3 different angles depending upon user preference.

- 1 Press the **ANGLE ▲▼** button to adjust the angle of the movable display.

NOTES

- The display will close a half minute after the ignition key is turned to the OFF position.
- The adjusted angle of the display is stored in memory. There is no need to re-adjust the angle when the power is turned back on.

CAUTION

Keep hands (or any other object) away from the display while it is opening or closing to avoid damage or injury. The back of the movable display will get very warm under normal operating conditions. This is not a malfunction. Do not touch.

Adjusting Volume/Balance (Between Left and Right)/Fader (Between Front and Rear)/Defeat

- 1 Press the **MODE (Rotary encoder)** button repeatedly to choose the desired mode.

Each press changes the modes as follows:

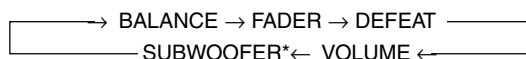

Volume : 0 ~ 35
 Balance : L15 ~ R15
 Fader: R15 ~ F15
 Subwoofer: 0 ~ +15

NOTES

- If the **MODE** button is not pressed within 5 seconds after selecting the **BALANCE**, **FADER**, **DEFEAT** or **SUBWOOFER** mode, the unit automatically returns to the **VOLUME** mode.
- * When the subwoofer mode is **OFF**, its level cannot be adjusted.

- 2 Turn the **Rotary encoder** until the desired sound is obtained in each mode.
 By setting Defeat ON, previously adjusted settings of BASS, Treble will return to the factory defaults, but MX will be turned off.

Audio Mute Function

Activating this function will instantly lower the volume level by 20 dB.

- 1 Press the **MUTE** button to activate the MUTE mode. The audio level will decrease by about 20 dB. Pressing the **MUTE** button again will bring the audio back to its previous level.

Displaying Time

- 1 Press the **CLK** (clock) button repeatedly until the time is displayed.

Each press changes the modes as follows:

Radio mode

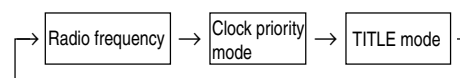

CD Player/Changer modes

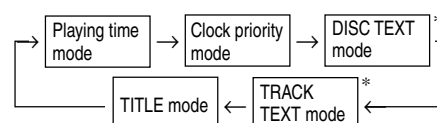

NOTES

- Selecting any tuner or CD function while in the clock priority mode will interrupt the time display momentarily. The function selected will be displayed for about 5 seconds before the time returns to the display.
- When the power is off but the ignition key is on, press the **CLK** button to display the time.
- * The display above is shown with a CD-TEXT compatible changer connected.

Setting Time

- 1 In the Clock priority mode, press and hold the **CLK** (clock) button for at least 3 seconds while the time is displayed. The time indication will blink.
- 2 Turn the **Rotary encoder** to adjust the hours while the time indication is blinking.
- 3 When the hour has been adjusted, press the **Rotary encoder**.
- 4 Turn the **Rotary encoder** to adjust the minutes while the time indication is blinking. The time is automatically set 5 seconds after the minute adjustment. The time can also be manually set by pressing the **Rotary encoder**.

Basic Operation

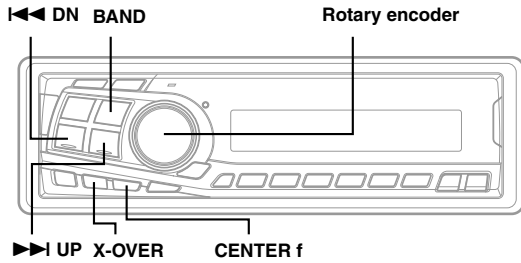

Setting the Bass Control

You can change the Bass Frequency emphasis to create your own tonal preference.

- 1 Press the **CENTER f** button to select the BASS (bass Center frequency) control mode.

→ BASS → TREBLE → normal mode ←

- 2-1 Setting the bass Center frequency:

Press the **DN BAND** or **UP X-OVER** button to select the desired bass center frequency.

→ 60Hz ↔ 70Hz ↔ 80Hz ↔ 90Hz ←
→ 180Hz ↔ 150Hz ↔ 130Hz ↔ 100Hz ←

Emphasizes the displayed Bass frequency ranges.

- 2-2 Setting the bass Band Width (Q-Factor):

Press the **BAND** button to select the desired bass Band Width.

→ B. Width1 → B. Width2 → B. Width3 → B. Width4
(Wide) ←.....→ (Narrow)

Changes the bass boost band width to wide or narrow. A wide setting will boost a wide range of frequencies above and below the center frequency. A narrower setting will boost only frequencies near the center frequency.

- 2-3 Setting the bass Level:

Turn the **Rotary encoder** to select the desired bass Level (-7~+7). You can emphasize or weaken the bass frequency.

NOTES

- If no buttons are pressed within 5 seconds, the Bass control setting will be turned off automatically.
- The settings of the Bass Level will be individually memorized for each source (FM, AM, CD, etc.) until the setting is changed. Once you set Bass frequency and Bass Band Width for one of sources (FM, AM, CD, etc.), this setting becomes effective for all those sources. Depending on the connected devices, some functions and display indications do not work.
- This function is inoperable when DEFEAT is ON.

Setting the Treble Control

You can change the Treble Frequency emphasis to create your own tonal preference.

- 1 Press the **CENTER f** button to select the TREBLE (treble Center frequency) control mode.

→ BASS → TREBLE → normal mode ←

- 2-1 Setting the treble Center frequency:

Press **DN BAND** or **UP X-OVER** button to select the desired treble Center frequency.

→ 10.0kHz ↔ 12.5kHz ↔ 15.0kHz ↔ 17.5kHz ←

Emphasizes the displayed Treble frequency ranges.

- 2-2 Setting the treble Level:

Turn the **Rotary encoder** to select the desired Treble Level (-7~+7).

You can emphasize the treble frequency.

NOTES

- If no buttons are pressed within 5 seconds, the Treble control setting will be turned off automatically.
- The settings of the Treble Level will be individually memorized for each source (FM, AM, CD, etc.) until the setting is changed. Once you set Treble frequency for one of sources (FM, AM, CD, etc.), this setting becomes effective for all those sources. Depending on the connected devices, some functions and display indications do not work.
- This function is inoperable when DEFEAT is ON.

Adjusting the built-in Crossover

The High and Low Pass Filters on this unit can be adjusted to suit your personal taste.

- 1 Press and hold the **X-OVER** button for at least 2 seconds.

→ HPF ←<Press momentarily> LPF* ←<Press momentarily>
←<Press for at least 2 seconds> normal mode ←

- * When the subwoofer output of this unit is turned OFF, LPF and phase are deactivated.

- 2 Press the **DN BAND** or **UP X-OVER** button to select the desired setting.

1. HPF (Setting the High Pass Filter):

FLAT (OFF) ↔ 80Hz ↔ 120Hz ↔ 160Hz

Outputs all frequencies higher than that selected according to your preference.

NOTES

- If no buttons are pressed within 5 seconds, the setup menu returns to the normal audio display.
- These functions are inoperative when an external, Ai-NET processor is connected.
- If HPF, LPF, Bass Control and Treble Control are all set to ON, depending on the Bass Control and Treble Control settings, you may not be able to reinforce the sound effect.
- Except when the HPF and LPF is turned OFF, the subwoofer is in monaural mode.
- When the subwoofer is set to OFF, LPF mode and change of phase does not work.

About the Time Correction

The distance between the listener and the speakers in a car vary widely due to the special conditions of the mobile environment. This difference in the distances from the speakers to the listener creates a shift in the sounds image and frequency characteristics. This is caused by the time delay between the sound reaching the listener's right versus the left ear.

To correct this, the CDA-7892E is able to delay the audio signal to the speakers closest to the listener. This effectively creates a perception of increased distance for those speakers. The listener can be placed at an equal distance between the left and right speakers for optimum staging. The adjustment will be made for each speaker in a step of 0.1 ms.

Example 1. Listening Position: Front Left Seat

Adjust the time correction level of the front left speaker to a high value and the rear right to zero or a low value.

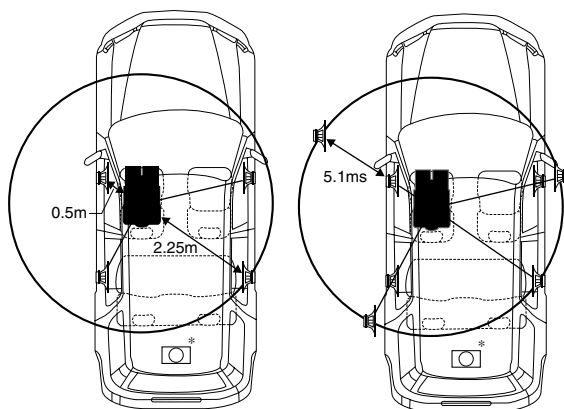

Tips

* Subwoofer speaker.

You cannot change the Time Correction value for the subwoofer, but you can set the subwoofer's apparent position to the front by adjusting the Time Correction value of the front and rear speakers.

For details, refer to the "Tips" on page 8.

Here we calculate the time correction value for the front left speaker in the diagram at the left.

Conditions:

Farthest Speaker – listening position: 2.25 m (88-9/16")

Front left speaker – listening position: 0.5 m (19-11/16")

Calculation: $L = 2.25 \text{ m} - 0.5 \text{ m} = 1.75 \text{ m}$ (68-7/8")

Time correction = $1.75 \div 343^* \times 1000 = 5.1 \text{ (ms)}$

*Speed of sound: 343 m/s (765 mph) at 20°C

In other words, giving the front left speaker a time correction value of 5.1 ms makes it seem as if the distance to the front left speaker is the same as the distance to the farthest speaker.

The sound is not balanced because the distance between the listening position and the various speakers is different. The difference in distance between the front left speaker and the rear right speaker is 1.75 m (68-7/8").

Time correction eliminates the differences in the time required for the sound to reach the listening position. The time of the front left speaker is corrected by 5.1 ms so that its sound reaches the listening position at the same time as the sound of other speakers.

Example 2. Listening Position: All Seats

Adjust the time correction level of each speaker to almost the same level.

- 1 Sit in the listening position (driver's seat, etc.) and measure the distance (in meters) between your head and the various speakers.
- 2 Calculate the difference between the distance to the farthest speaker and the other speakers.
 $L = (\text{distance to farthest speaker}) - (\text{distance to other speakers})$
- 3 Divide the distances calculated for the speakers by the speed of sound (343 m/s (765 mph) at 20°C). These values are the time correction values for the different speakers.

Basic Operation

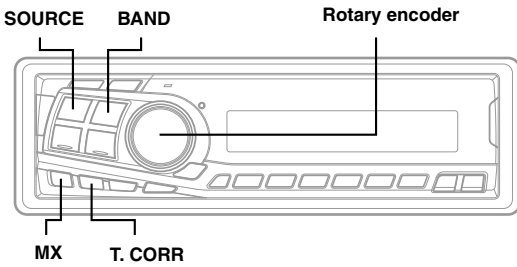

NOTES

- Any manual time correction adjustments will also affect corrections made in Bass Focus.
- Time Correction mode is automatically canceled if no buttons are pressed within 15 seconds.

Example of Steps 2 and 3 Setting

- (1) After entering corrections for the front (left and right) speakers in STEP 15, the time difference is 1.5 ms for both front-left and front-right speakers.

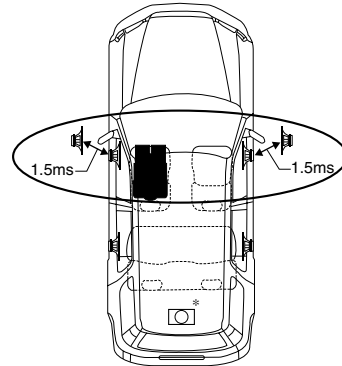

Bass Focus

The time difference between the front-rear/left-right speakers, can be adjusted at the same time. With an initial delay of 0.1 ms for each of the 0 to 99 steps, audible time correction can be done.

- 1 Press the **T.CORR** button to select the Bass Focus mode.

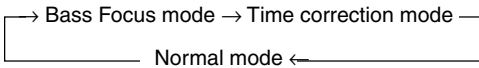

- 2 Press the **BAND** button to select the front-rear / left-right speakers.

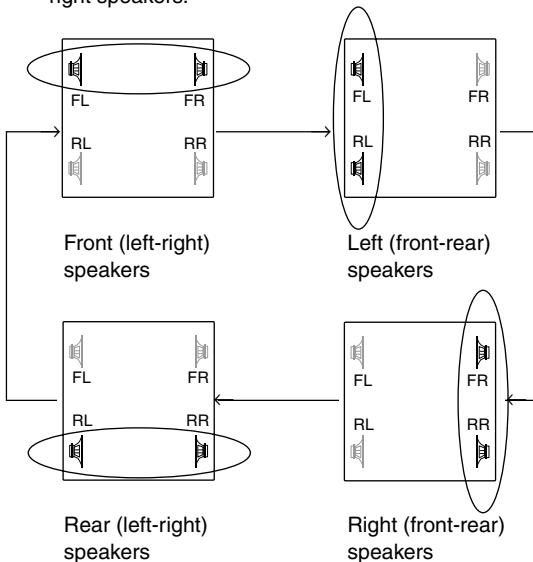

- (2) After entering corrections for the left (front and rear) speakers in STEP 15, the time difference becomes 3.0 ms* for the front left speaker and 1.5 ms for the left rear speaker.

* Because the time difference was already set to 1.5 ms for the front left speaker in STEP 1, the additional correction in STEP 15 makes the time difference of the front left speaker 3.0 ms.

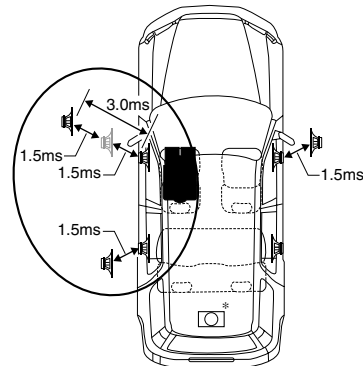

Tips

* Subwoofer speaker.

Delay (turn the rotary encoder) the audio signal to the front (left and right) speakers to make the apparent position of the subwoofer to be at the front. In doing this, the apparent position between the front (left and right) speakers and subwoofer will appear equal to the driver. After performing above, you can change the positions of left and right speakers by delaying the time .

- 3 Turn the **Rotary encoder** to adjust the front-rear / left-right delay.

- 4 For setting another channel (speaker), repeat the steps 2 and 3.

- 5 After setting, press the **T. CORR** to return to the normal mode.

Time Difference Table

Number of Steps	Time Difference (ms)	Number of Steps	Time Difference (ms)	Number of Steps	Time Difference (ms)
0	0.0	14	1.4	28	2.8
1	0.1	15	1.5	29	2.9
2	0.2	16	1.6	30	3.0
3	0.3	17	1.7	31	3.1
4	0.4	18	1.8	32	3.2
5	0.5	19	1.9	33	3.3
6	0.6	20	2.0	34	3.4
7	0.7	21	2.1	35	3.5
8	0.8	22	2.2	36	3.6
9	0.9	23	2.3	37	3.7
10	1.0	24	2.4	38	3.8
11	1.1	25	2.5	39	3.9
12	1.2	26	2.6	40 - 98	4.0 - 9.8
13	1.3	27	2.7	99	9.9

Time Correction

Before performing the following procedures, refer to "About the Time Correction" (page 7).

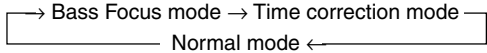
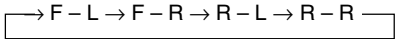
- Select the time correction mode by pressing the **T.CORR** button.
Each press changes the modes as follows:

- Select a speaker to be adjusted by pressing the **BAND** button.

- Adjust the desired time correction value by turning the **Rotary encoder**.
- For setting another speaker, repeat the step 2 and 3.
- After setting, press the **Rotary encoder** to return to the normal mode.

NOTE

Time Correction mode is automatically canceled if no buttons are pressed within 15 seconds.

Setting the MX Mode

MX (Media Xpander) makes vocals or instruments sound distinct regardless of the music source. The radio, CD, and MP3, will be able to reproduce the music clearly even in cars with a lot of road noise.

- Press the **MX** button to select MX ON.
- Press the **SOURCE** button to select the source you want to MX (Media Xpander)-correct.
- Press and hold the **MX** button for at least 2 seconds to select the MX mode.
- Turn the **Rotary encoder** to select your preferred mode or OFF (NON EFCT).

FM (MX level 1 to 3):

The medium to high frequencies become more clear, and produces well balanced sound in all the bands.

CD (MX level 1 to 3):

CD mode processes a large quantity of data. This data is used to reproduce the sound cleanly by making use of the data quantity.

MP3 (MX level 1 to 3):

This corrects information that was omitted at the time of compression. This reproduces a well-balanced sound close to the original.

DVD (Video CD) (MX level 1 to 2):

The dialog portion of the video is reproduced more clearly.

DVD (CD) (MX level 1):

This disk contains a large quantity of data such as music clip. MX uses this data to reproduce the sound accurately.

AUX (MX level 1):

Choose the MX mode (MP3, MUSIC, or MOVIE) that corresponds to the media connected.

- After setting, press the **Rotary encoder** to return to the normal mode.

NOTES

- By "Setting the Defeat of the external input" (page 15) to ON, operation is bypassed.
- To cancel MX mode for all music sources, press the **MX** button to turn MX off.
- MX mode is automatically canceled if no buttons are pressed within 15 seconds.
- Each music source, such as radio, CD, and MP3 can have its own MX setting.
- On disks with both MP3 and CD-DA, when the source changes from "MP3 to CD-DA" or "CD-DA to MP3", after a CD Changer compatible with MP3 has been connected, the MX-mode switching process may take a little time before a piece is played due to.
- This function is inoperable when DEFEAT is ON.

Basic Operation

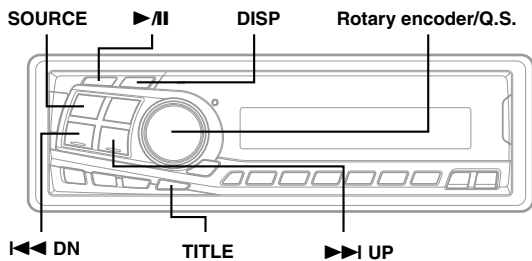

Quick Searching Function

You can easily select the tracks and files.

- 1 Press the **SOURCE** button to set the desired source mode.
(CD mode is explained here as an example)
- 2 When setting the CD mode, press and hold the **Q.S.** button for at least 2 seconds. The mode changes to the Q.S. (Quick Search) setting.
- 3 Select a desired track by turning the **Rotary encoder** to the right or left.
 - CD/Changer mode: Track can be selected.
 - MP3 changer mode: File number can be selected.
- 4 When the setting is completed, the Q.S. mode is canceled by pressing the **Rotary encoder**.

NOTES

The Q.S. mode is canceled by deactivating for 10 seconds in the above operation, step 2 and 3.

Changing the Audio Level Display ON/OFF

- 1 Press the **DISP** button to switch Audio Level Display ON or OFF.

Displaying the Title/Text

It is possible to display the CD/Station title if the title has been previously inputted. For details, see "Titling Disc/Stations" (page 11). Text information, such as the disc name and the track name, will be displayed if connecting a CD text compatible CD changer and playing a CD text compatible disc in the changer. If connecting MP3 compatible CD changer, it is also possible to display the folder name, the file name, and the ID3 tag, etc. while playing MP3 files.

- 1 Press the **TITLE** button.
The mode will change every time the button is pressed.

About "Title" and "Text"

Title: With this device, it is possible to input the CD/Station name (refer to page 11). This inputted name is referred to as a "title." When you connect a changer compatible with MP3, you cannot input or display titles on MP3 discs.

Text: Text compatible CDs contain text information such as the disc name and track name. Such text information is referred to as "text."

Radio mode:

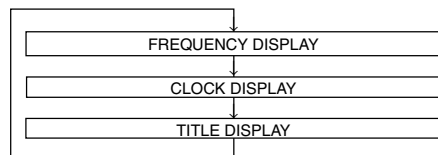

CD/Changer mode:

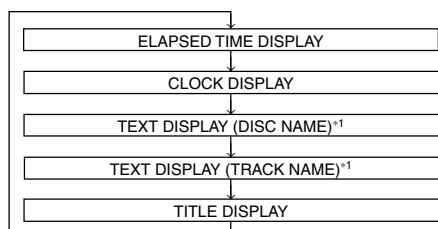

MP3 Changer mode:

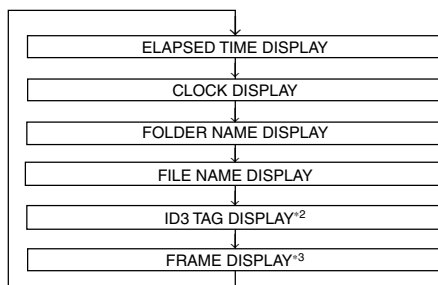

- *1 The display is shown with a CD-TEXT compatible changer is connected. Displayed during playback of a disc with CD Text. "NO TEXT" will be displayed when the CD contains no Text data.
- *2 If an MP3 file contains ID3 tag information, all the ID3 tag information is displayed (e.g., track name, artist name, and album name). All other tag data is ignored.
"NO TAG" will be displayed when an MP3 file contains no ID3 tag information.
- *3 The recording sampling rate and bit rate of the MP3 file are displayed.

NOTES

- Some characters may not be displayed correctly with this device, depending on the character type.
- The CD changer must also be CD Text compatible for the Text information to be displayed.
- When the Scroll Setting (refer to page 13) is set to "SCROLL MANU", press and hold the TITLE button for at least 3 seconds to scroll the Text information only once (TEXT DISPLAY, FOLDER NAME DISPLAY, FILE NAME DISPLAY or ID3 TAG DISPLAY mode).
- "NO SUPRT" is displayed when the desired text information cannot be displayed on this unit.
- If the title was not previously input, "NO TITLE" is displayed.

Titling Discs/Stations

It is possible to title your favorite CD's or radio stations. When you connect a changer compatible with MP3, you cannot input titles on MP3 discs.

- 1 Press the **TITLE** button and select the title display mode.
For details, see Displaying the Title/Text (page 10).
- 2 Press and hold the **TITLE** button for at least 3 seconds. The first character will blink.
- 3 Turn the **Rotary encoder** to select the desired letter/numeral/symbol available for naming.
- 4 Press the **Rotary encoder** to store the first character. The first character will stop blinking and the display will automatically advance to the next character. When that character begins to blink, you may choose the next letter or symbol of your title.
- 5 Repeat the steps 3 and 4 above to complete the titling. Pressing the **Rotary encoder** after entering the 8th character, automatically stores the title into memory.

When entering a title of less than 8 characters (for example, 3 character title):

After entering 3 characters to complete your title, the 4th character space will be blinking. Go to step 6 to complete the title.

- 6 Press the **TITLE** button to record the title.

NOTES

- You can enter 24 radio station titles and 18 CD titles on this unit. If you try to store beyond the limit, the display will show "FULL DATA." At this point, no more titles can be stored.
- The CD Changer title length or memory capacity varies depending upon the model being used.
- To input a new title, one of the previously inputted titles must first be deleted.
- When you want to erase a title, enter the "⏏" symbol into all spaces.
- The operations described in steps 3 to 5 must be made within 10 seconds. The input mode will be cancelled if no action is taken for over 10 seconds.
- Removing power from the unit may delete these titles. Use caution when manipulating the power cord.

Erasing Disc Title/Station Title

- 1 Press the **TITLE** button to select the titling mode. Then, press and hold for at least 3 seconds.
- 2 Press and hold the **▶/||** button for at least 2 seconds to activate the title scanning mode. The title in the display will blink.
- 3 Press the **◀◀ DN** or **▶▶ UP** button repeatedly until the title you want to erase is displayed.
- 4 Press and hold the **▶/||** button for at least 2 seconds to erase the title displayed.
- 5 Press the **TITLE** button to cancel the title erasing mode.

NOTE

You cannot erase CD-TEXT.

SETUP Operation

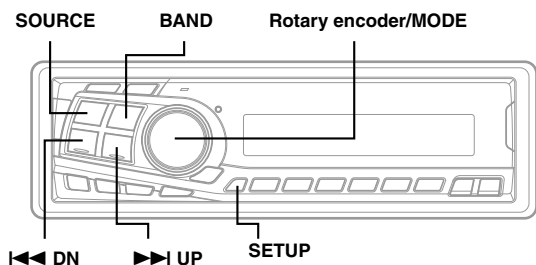

Switching the Tuner Mode

The CDA-7892E incorporates the MAX TUNE SQ for the highest quality tuner audio. Moreover, you can choose between two settings to suit your own personal sound preferences and usage.

- 1 Press and hold the **SETUP** button for at least 3 seconds.
 - 2 Press the **>>> UP** or **I<<< DN** button to select "NORMAL or HI-FI."
 - 3 Press the **BAND** button to switch the TUNER mode.
HI-FI ↔ NORMAL
NORMAL: Standard setting
HI-FI: Sound quality priority setting
- NOTES**
- The initial setting at the factory is "NORMAL."
 - If you find the sound is very noisy while listening to the tuner in the HI-FI mode, we recommend you change to the NORMAL mode.
- 4 When the setting is completed, press the **SETUP** button to return to the normal mode.

Subwoofer On and Off

- 1 Press and hold the **SETUP** button for at least 3 seconds.
 - 2 Press the **>>> UP** or **I<<< DN** button to select "SUB (Subwoofer)."
 - 3 Press the **BAND** button to toggle mode between SUB-W ON and SUBW OFF.
- NOTE**
The initial setting at the factory is SUB-W ON.
- 4 Press the **SETUP** button after setting the SUB-W ON.

- 5 Press the **MODE** button repeatedly to select the SUB-W mode.

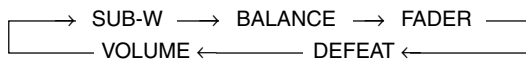

Press the **I<<< DN** or **>>> UP** button after selecting the SUB-W mode, and the subwoofer output phase is toggled SUBW NOR (0°) or SUBW REV (180°).

- 6 Turn the **Rotary encoder** until the desired sound is obtained in each mode.

Sound (Beep) Guide Function

This function will give audible feedback with varying tones depending upon the button pressed.

- 1 Press and hold the **SETUP** button for at least 3 seconds.
 - 2 Press the **>>> UP** or **I<<< DN** button to select "BEEP"
 - 3 Press the **BAND** button to toggle the mode between BEEP ON and BEEP OFF.
- NOTE**
The initial setting at the factory is BEEP ON.
- 4 Press the **SETUP** button to set the selected mode.

Turning Mute Mode On/Off

If a device having the interrupt feature is connected, audio will be automatically muted whenever the interrupt signal is received from the device. This function can be turned ON or OFF from the head unit by following procedure below.

- 1 Press and hold the **SETUP** button for at least 3 seconds.
 - 2 Press the **▶▶I UP** or **I◀◀ DN** button to select the MUTE mode.
 - 3 Press the **BAND** button to turn on or off the MUTE mode.
Each press toggles between the MUTE ON and OFF modes.
- NOTE**
The initial setting at the factory is "MUTE ON."
- 4 Press the **SETUP** button again to return to normal operation.

Scroll Setting

This CD player allows to scroll the disc and track name recorded on CD-Text discs if the CD changer compatible with CD-Text is connected. The folders names, files names and ID3 TAG can also be scrolled while playing MP3 when the CD changer compatible with MP3 is connected. This feature will not work for the disc titles that were input manually.

- 1 Press and hold the **SETUP** button for at least 3 seconds.
- 2 Press the **▶▶I UP** or **I◀◀ DN** button to select "SCR"(SCROLL).
- 3 Press the **BAND** button to toggle mode between SCR AUTO and MANU.
 - SCR AUTO: the display of CD text is scrolled continuously.
 - SCR MANU: the display is scrolled only once when a disc is loaded or when a track is changed, etc.
- 4 When the setting is completed, press the **SETUP** button to return to the normal mode.

NOTES

- Initial mode is "SCR MANU."
- The unit scrolls only CD text names. The disc titles input manually (refer to page 11) cannot be scrolled.

Setting the AUX Mode (V-Link)

You can input TV/video sound by connecting an optional Ai-NET/RCA Interface cable (KCA-121B) or Versatile Link Terminal (KCA-410C) to this component.

- 1 Press and hold the **SETUP** button for at least 3 seconds.
 - 2 Press the **▶▶I UP** or **I◀◀ DN** button to select "AUX."
 - 3 Press the **BAND** button to toggle the mode between AUX ON and AUX OFF.
- NOTES**
- The initial setting at the factory is AUX OFF.
 - You can set the AUX mode display by pressing the **I◀◀ DN** or **▶▶I UP** button after AUX ON is set, select the AUX mode display setting, and then press the **BAND** button.
 - When connecting the KCA-410C, you can set two AUX mode displays.
- 4 Press the **SETUP** button to return to normal mode.
 - 5 To adjust the volume, etc., first press the **SOURCE** button and select the AUX mode, then make the necessary adjustment.

NOTE

When using the Versatile Link Terminal (KCA-410C), you can connect two external inputs. To select the mode, press the **BAND** button on the unit.

SETUP Operation

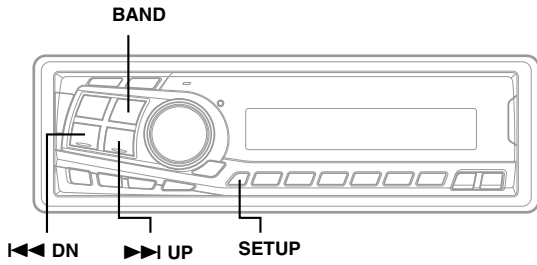

Connecting to an External Amplifier

When an external amplifier is connected, sound quality can be improved by stopping the power supply of the built-in amplifier. The power output is set to OFF by the following procedure.

- 1 Press and hold the **SETUP** button for at least 3 seconds.
- 2 Press the **UP** or **DN** button to select "PWR".
- 3 Press the **BAND** button to toggle the mode between PWR ON and PWR OFF.

PWR OFF:

When activating the speakers, this setting can be performed by connecting between the front and rear pre-amplifier of the unit and the external amplifier. In this setting, nothing is output to the speakers.

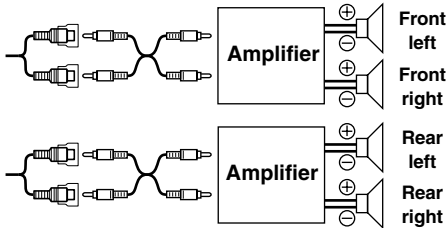

PWR ON:

The speakers are driven by the built-in amplifier.

Speakers

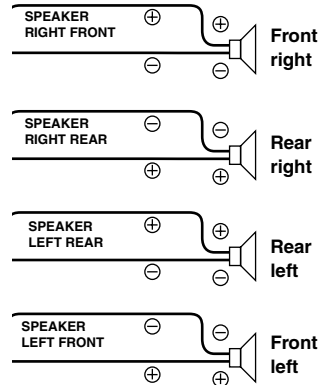

NOTE

No sound is produced by the system when the power output is set to OFF.

- 4 Press the **SETUP** button to return to normal mode.

Setting the Defeat of the External Input

When auxiliary devices such as a TV or video game etc. are used with this unit, you can use the audio function to set the mode between BASS, TREBLE and MX Defeat ON/OFF.

- 1 Press and hold the **SETUP** button for at least 3 seconds.
- 2 Press the **▶▶ UP** or **◀◀ DN** button to select "INT."
- 3 Press the **BAND** button to toggle the mode between INT ON and INT OFF.
When using Initial mode, set this to ON.
When the Initial mode is not selected, set this to OFF.
- 4 Press the **SETUP** button to return to normal mode.

Demonstration

This unit has a Demonstration feature which simulates the display functions.

- 1 Press and hold the **SETUP** button for at least 3 seconds.
- 2 Press the **▶▶ UP** or **◀◀ DN** button to select the DEMO mode.
- 3 Press the **BAND** button to turn on or off the DEMO mode.
Each press toggles between DEMO ON and DEMO OFF.
If no button is pressed for 30 seconds, the DEMO mode activates.
NOTES
 - The initial setting at the factory is "DEMO OFF."
 - To quit DEMO mode, set to "DEMO OFF."
- 4 Press the **SETUP** button again to return to normal operation.

Radio Operation

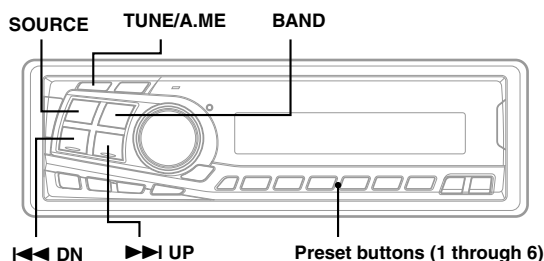

Manual Tuning

- 1 Press the **SOURCE** button until a radio frequency appears in the display.
- 2 Press the **BAND** button repeatedly until the desired radio band is displayed.
Each press changes the band:
→ FM1 → FM2 → AM →
- 3 Press the **TUNE** button repeatedly until "DX SEEK" and "SEEK" disappear from the display.

NOTE

The initial mode is DX SEEK.

- 4 Press the **DN** or **UP** button to move downward or upward one step respectively until the desired station frequency is displayed.

NOTE

The ST indicator appears on the display when a Stereo FM station is tuned in.

Automatic Seek Tuning

- 1 Press the **SOURCE** button until a radio frequency appears in the display.
- 2 Press the **BAND** button repeatedly until the desired radio band is displayed.
Each press changes the band:
→ FM1 → FM2 → AM →
- 3 Press the **TUNE** button to illuminate the DX and SEEK indicators in the display.
With the DX (Distance) mode activated, both strong and weak stations will be tuned in the Auto-Seek operation.
Press again to return to the local mode. The DX indicator will turn off and the SEEK indicator will remain illuminated. Now, only strong stations will be tuned.
- 4 Press the **DN** or **UP** button to automatically seek for a station downward or upward respectively. The unit will stop at the next station it finds. Press the same button again to seek the next station.

Manual Storing of Station Presets

- 1 Select the radio band and tune in a desired radio station you wish to store in the preset memory.
- 2 Press and hold any one of the **Preset buttons (1 through 6)** that you want to store the station on for at least 2 seconds. The selected station is stored. The display shows the band, preset No. with a triangle (△) and station frequency memorized.
- 3 Repeat the procedure to store up to 5 other stations onto the same band.
To use this procedure for other bands, simply select the band desired and repeat the procedure.
A total of 18 stations can be stored in the preset memory (6 stations for each band; FM1, FM2 and AM).

NOTE

If you store a station in a preset memory which already has a station, the current station will be cleared and replaced with the new station.

Automatic Memory of Station Presets

- 1 Press the **SOURCE** button to select the radio mode.
- 2 Press the **BAND** button repeatedly until the desired radio band is displayed.
- 3 Press and hold the **A. ME** button for at least 2 seconds. The frequency on the display continues to change while the automatic memory is in progress. The tuner will automatically seek and store 6 strong stations in the selected band. They will be stored into buttons 1 to 6 in order of signal strength.
When the automatic memory has been completed, the tuner goes to the station stored in the preset location No. 1.

NOTE

If no stations are stored, the tuner will return to the original station you were listening to before the auto memory procedure began.

Tuning to Preset Stations

- 1 Press the **SOURCE** button to select the radio mode.
- 2 Press the **BAND** button repeatedly until the desired band is displayed.
- 3 Press the station **Preset** button that has your desired radio station in memory.
The display shows the band, preset number with a triangle and frequency of the station selected.

CD Player Operation

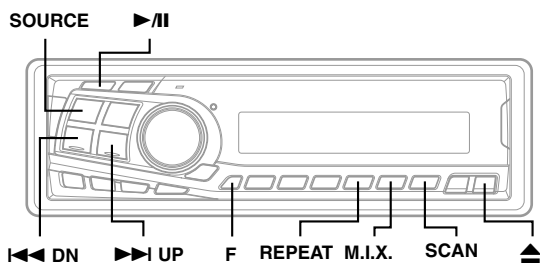

Opening and Closing the Movable display

- 1 Press the **EJECT** button.
The movable display will open.

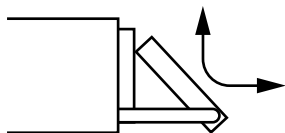

To close the movable display, press the **EJECT** button again. The movable display will close.

NOTES

- Do not apply shock to the movable display when it is open as it may result in malfunction of the unit.
- The display may be dim during low temperatures and immediately after turning on the power. The brightness will return to normal as time elapses.
- The display will stop at the set angle when closing.

CAUTION

Keep hands (or any other object) away from the display while it is opening or closing to avoid damage or injury. The back of the movable display will get very warm under normal operating conditions. This is not a malfunction. Do not touch.

Playback

- 1 Press the **EJECT** button.
The movable display will open.

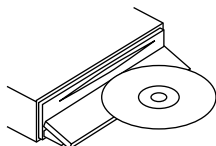

Insert a disc with the label side facing up.

- 2 Insert a disc with the label side facing up.
The disc will be pulled into the unit automatically. The movable display will close and playback will begin.

When a disc is already inserted, press the **SOURCE** button to switch to the CD mode.

The mode will change every time the button is pressed.

→ TUNER → CD → CD CHANGER* →

(* Only when the CD changer is connected)

- 3 To pause playback, press the **PAUSE/STOP** button. Pressing the **PAUSE/STOP** button again will resume playback.
- 4 To eject the disc, press the **EJECT** button.

NOTES

- Do not insert or remove a CD when loading or ejecting a CD, as malfunction may result.
- If the CD does not eject, press **EJECT** button again for more than 3 seconds with the movable display open.

About the usable discs.

We recommend using only compact discs containing the marks shown below.

You can play CD-Rs (CD-Recordable)/CD-RWs (CD-ReWritable) for audio use on this unit. You can not play CD-Rs/CD-RWs containing MP3 formatted audio files.

- Some of the following CDs may not play on this unit: Flawed CDs, CDs with fingerprints, CDs exposed to extreme temperatures or sunlight (e.g., left in the car or this unit), CDs recorded under unstable conditions, CDs not designed for audio use, CDs on which a recording failed or a re-recording was attempted.



On handling Compact Discs (CD/CD-R/CD-RW)

- Do not touch the surface.
- Do not expose the disc to direct sunlight.
- Do not affix stickers or labels and do not write on the surface.
- Clean the disc when it is dusty.
- Make sure that there are no bumps around the disc.
- Do not use commercially available disc accessories.

Do not leave the disc in the car or the unit for a long time. Never expose the disc to direct sunlight. Heat and humidity may damage the CD and you may not be able to play it again.

Music Sensor (Skip)

- 1 Momentarily press the **⏮ DN** button once during CD play to return to the beginning of the current track. If you wish to access the beginning of a track further back, repeatedly press until you reach the desired track.

Press the **⏭ UP** button once to advance to the beginning of the next track. If you wish to access the beginning of a track further ahead, press repeatedly until the desired track is reached.

NOTE

The music sensor feature is functional in the play or pause mode.

Fast Forward and Backward

- 1 Press and hold the **⏮ DN** or **⏭ UP** button to quickly move backward or forward until you reach the desired section of the track.

Repeat Play

- 1 Press the **REPEAT** button to play back repeatedly the track being played. The track will be played repeatedly.

Press the **REPEAT** button again and select OFF to deactivate the repeat play.

NOTES

- If a CD Changer is connected and the RPT ALL mode is selected, the unit repeatedly plays back all tracks on the disc selected.

→ RPT → RPT ALL → (off) →

- In case a 6-disc CD changer is connected:
In CD changer mode, press the "F" button to illuminate the "FUNC" indicator and go to step 1 within 5 seconds.
- In case a 12-disc CD changer is connected:
In changer mode, press the "F" button twice to illuminate the "FUNC" indicator and go to step 1 within 5 seconds.

M.I.X. (Random Play)

- 1 Press the **M.I.X.** button in the play or pause mode. The tracks on the disc will be played back in a random sequence.

To cancel M.I.X. play, press the **M.I.X.** button again to turn off the M.I.X.

NOTES

- If a CD Changer equipped with the ALL M.I.X. function is connected, ALL M.I.X. will also be selectable. In this mode, the tracks on all the CDs in the current magazine will be included in the random playback sequence.
- In case a 6-disc CD changer is connected:
In CD changer mode, press the "F" button to illuminate the "FUNC" indicator and go to step 1 within 5 seconds.
- In case a 12-disc CD changer is connected:
In CD changer mode, press the "F" button twice to illuminate the "FUNC" indicator and go to step 1 within 5 seconds.

→ M.I.X. → ALL M.I.X. → (off) →

Scanning Programmes

- 1 Press the **SCAN** button to activate the Scan mode. The first 10 seconds of each track will be played back in succession.

To stop scanning, press the **SCAN** button and deactivate the Scan mode.

NOTES

- In case a 6-disc CD changer is connected:
In CD changer mode, press the "F" button to illuminate the "FUNC" indicator and go to step 1 within 5 seconds.
- In case a 12-disc CD changer is connected:
In CD changer mode, press the "F" button twice to illuminate the "FUNC" indicator and go to step 1 within 5 seconds.

CD Player Operation

Multi-Changer Selection

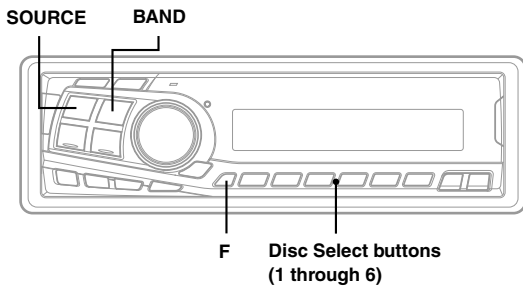

Alpine's Ai-NET system will support up to 6 CD Changers. When operating two or more changers, the KCA-400C (Multi-Changer Switching device) must be used. If you use 1 Switching device, you can connect up to 4 CD Changers. If you use 2 Switching devices, you can connect up to 6 CD Changers. When using KCA-410C (Versatile Link Terminal), you can connect two changers and two external outputs (AUX).

Controlling CD Changer (Optional)

An optional 6-disc or 12-disc CD Changer may be connected to the CDA-7892E if it is Ai-NET compatible. With a CD Changer connected to the Ai-NET input of the CDA-7892E, the CD Changer will be controllable from the CDA-7892E.

Using the KCA-400C (Multi-Changer Switching device) or the KCA-410C (Versatile Link Terminal) multiple changers can be controlled by the CDA-7892E. See the Multi-Changer Selection section on this page for selecting the CD Changers.

NOTES

- The controls on the CDA-7892E for CD Changer operation are operative only when a CD Changer is connected.
- The "Changer" indicator illuminates when a CD Changer is connected.
- The DVD changer (optional) is controllable from the CDA-7892E as well as the CD changer.

- 1 Press the **SOURCE** button to activate the CHANGER mode. The display shows the disc number and track number.

NOTE

The source indicator varies depending on the connected source.

- 2 Press the **Disc Select buttons (1 through 6)** corresponding to one of the discs loaded in the CD Changer. The selected disc number appears in the display and CD playback starts.

NOTES

- After selecting the desired disc, you can operate in the same way as for the CDA-7892E CD player.
For details, please see the CD Operation section.
- If the "FUNC" indicator is illuminated the Disc Select buttons become nonfunctional.

When a 12-disc CD Changer is connected:

To select discs numbered from 1 to 6, the procedure is the same as for the 6-disc CD Changer. To select discs numbered from 7 to 12, first press the "F" button. This changes the "D" indicator to "d." Then press the desired Preset button. With the "F" button activated, the Preset buttons 1 to 6 will represent discs 7 to 12 respectively.

- 1 Press the **SOURCE** button to activate the CD Changer mode.

- 2 Press the **BAND** button to activate the CD Changer Selection mode.

- 3 The CD Changer Selection mode remains active for 8 seconds after step 2 is performed. Press the **BAND** button until the desired CD Changer indicator appears on the display.

NOTE

If the selected CD Changer is not connected, the display will show "NO CHGR."

- 4 To operate the selected changer, see "CD Player Operation" section.

NOTE

For further details about the external input (AUX) when using KCA-410C, see "Setting the AUX Mode (V-Link)" on page 13.

MP3 Changer Operation (Optional)

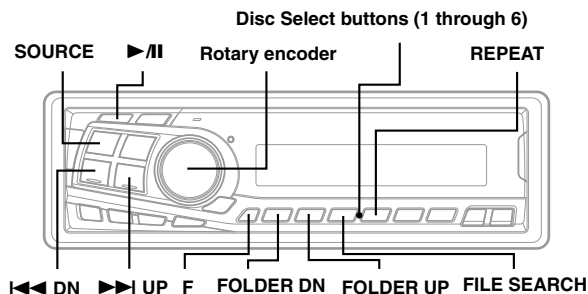

Playing MP3 Files

If you connect a changer compatible with MP3, you can play CD-ROMs, CD-Rs, and CD-RWs containing MP3 files on the CDA-7892E.

- 1 Press the **SOURCE** button to switch to the MP3 Changer mode. The display shows the disc number and file number.
- 2 Press the **Disc Select buttons (1 through 6)** corresponding to one of the discs loaded in the CD changer. The selected disc number appears in the display and playback of the CD starts.

To pause playback, press the **▶/||** button. Pressing the **▶/||** button again will resume playback.

NOTES

- The unit can play discs containing both audio data and MP3 data.
- If the "FUNC" indicator is illuminated, the disc select buttons become nonfunctional.
- If the **TITLE** button is pressed and held for at least 3 seconds, the display can be changed from the file number to the folder number. The folder number at this time is displayed for 5 seconds.

Music Sensor (Skip)

- 1 Momentarily press the **◀◀ DN** button once during CD play to return to the beginning of the current file. If you wish to access the beginning of a file further back, repeatedly press until you reach the desired file.

Press the **▶▶ UP** button once to advance to the beginning of the next file. If you wish to access the beginning of a file further ahead, press repeatedly until the desired file is reached.

NOTE

The music sensor feature is functional in the play or pause mode.

Fast Forward and Backward

- 1 Press and hold the **◀◀ DN** or **▶▶ UP** button to quickly move backward or forward until you reach the desired section of the file.

Selecting Folders

Perform the following operation within 5 seconds after the F button has been pressed and the FUNC indicator has lit.

- 1 Press the **FOLDER DN** or **FOLDER UP** button to select the folder.

File Search

You can locate all the files on a disc and play them. Perform the following operation within 5 seconds after the F button has been pressed and the FUNC indicator has lit.

- 1 Press the **FILE SEARCH** button during playback. The unit switches to File Search mode.
- 2 Turn the **Rotary encoder** to select the desired file.
- 3 Press the **Rotary encoder** to execute the setting. The selected file starts to play.

NOTE

During search, press the **FILE SEARCH** button to cancel the File Search mode.

Repeat Play

Perform the following operation within 5 seconds after the F button has been pressed and the FUNC indicator has lit.

- 1 Press the **REPEAT** button to play back the current file repeatedly. If the RPT ALL mode is selected, the disc will be played back repeatedly.

→ RPT → RPT ALL → (off) →

Press the **REPEAT** button and select OFF to deactivate repeat play.

NOTE

If you set **FOLDER** in the "Setting the Range of MP3 File Selection" section on page 22, and select the **RPT ALL** mode, the files in a folder will be played back repeatedly.

MP3 Changer Operation (Optional)

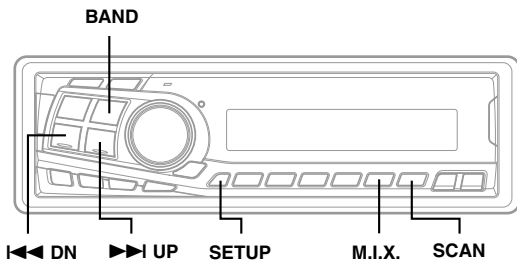

M.I.X. (Random Play)

Perform the following operation within 5 seconds after the F button has been pressed and the FUNC indicator has lit.

- 1 Press the **M.I.X.** button in the play or pause mode. The files on the disc will be played back in a random sequence. After all files on the disc have been played back, play will shift to the next disc. To cancel M.I.X. play, press the **M.I.X.** button to turn off the M.I.X.

NOTE

If you set **FOLDER** in the "Setting the Range of MP3 File Selection" section on this page, and select **M.I.X.**, the files in a folder will be played back in a random sequence. However, after all the tracks in a folder have been played back, play does not shift to the next folder.

Scanning Programmes

Perform the following operation within 5 seconds after the F button has been pressed and the FUNC indicator has lit.

- 1 Press the **SCAN** button to activate the Scan mode. The first 10 seconds of each file will be played back in succession. To stop scanning, press the **SCAN** button to deactivate the Scan mode.

NOTE

If you set **FOLDER** in the "Setting the Range of MP3 File Selection" section on this page, the first 10 seconds of each file in a folder will be played back.

Setting the Range of MP3 File Selection

You can set the range of MP3 file selection to "entire disc contents" or "folder contents only."

- 1 Press and hold the **SETUP** button for at least 3 seconds.
- 2 Press the **▶▶ UP** or **◀◀ DN** button to select **DISC/ FOLDER** (file selection range).
- 3 Press the **BAND** button to toggle the mode between **DISC ALL** and **FOLDER**.
 - **DISC ALL** : plays all the files on one disc
 - **FOLDER** : plays files in the selected folder only.
- 4 Press the **SETUP** button to set the selected mode.

NOTES

- The initial setting at the factory is **DISC ALL**.
- The range of MP3 file selection applies to **REPEAT**, **M.I.X.** and **SCAN** modes only.
In normal mode, the unit plays all files on a disc even when you set the range of MP3 selection to "folder contents only."

Playing MP3 Data

You can select either playback only of CD data, or playback of formatted CD data and MP3 files.

When a disc contains CD or the MP3 file data, playback starts from the CD data portion of the disc.

- 1 Press and hold the **SETUP** button for at least 3 seconds.
- 2 Press the **▶▶ UP** or **◀◀ DN** button to select "CD-DA."
- 3 Press the **BAND** button to toggle the mode between **CD-DA** and **CD/MP3**.
 - **CD-DA**: Only CD data can be played back.
 - **CD/MP3**: Both CD data and MP3 file tracks can be played back.
- 4 Press the **SETUP** button to return to normal mode.

Information

In Case of Difficulty

If you encounter a problem, please turn the power off, then on again. If the unit is still not functioning normally, please review the items in the following checklist. This guide will help you isolate the problem if the unit is at fault. Otherwise, make sure the rest of your system is properly connected or consult your authorized Alpine dealer.

Basic

No function or display.

- Vehicle's ignition is off.
 - If connected following instructions, the unit will not operate with the vehicle's ignition off.
- Improper power lead connections.
 - Check power lead connections.
- Blown fuse.
 - Check the fuse on the battery lead of the unit; replace with the proper value if necessary.
- Internal micro-computer malfunctioned due to interference noise etc.
 - Press the RESET switch with a ballpoint pen or other pointed article.

Radio

Unable to receive stations.

- No antenna or open connection in cable.
 - Make sure the antenna is properly connected; replace the antenna or cable if necessary.

Unable to tune stations in the seek mode.

- You are in a weak signal area.
 - Make sure the tuner is in the DX mode.
- If the area you are in is a primary signal area, the antenna may not be grounded and connected properly.
 - Check your antenna connections; make sure the antenna is properly grounded at its mounting location.
- The antenna may not be the proper length.
 - Make sure the antenna is fully extended; if broken, replace the antenna with a new one.

Broadcast is noisy.

- The antenna is not the proper length.
 - Extend the antenna fully; replace it if it is broken.
- The antenna is poorly grounded.
 - Make sure the antenna is grounded properly at its mounting location.

CD

CD Player/Changer not functioning.

- Out of operating temperature range +50°C (+120°F) for CD.
 - Allow the vehicle's interior (or trunk) temperature to cool.

CD playback sound is wavering.

- Moisture condensation in the CD Module.
 - Allow enough time for the condensation to evaporate (about 1 hour).

CD insertion not possible.

- A CD is already in the CD player.
 - Eject the CD and remove it.
- The CD is being improperly inserted.
 - Make sure the CD is being inserted following instructions in the CD Player Operation section.

Unable to fast forward or backward the CD.

- The CD has been damaged.
 - Eject the CD and discard it; using a damaged CD in your unit can cause damage to the mechanism.

CD playback sound skips due to vibration.

- Improper mounting of the unit.
 - Securely re-mount the unit.
- Disc is very dirty.
 - Clean the disc.
- Disc has scratches.
 - Change the disc.
- The pick-up lens is dirty.
 - Do not use a commercial available lens cleaner disc. Consult your nearest ALPINE dealer.

CD playback sound skips without vibration.

- Dirty or scratched disc.
 - Clean the disc; damaged disc should be replaced.

Error displays (built-in CD player only)

- Mechanical error
 - Press the ▲ button. After the error indication disappears, insert the disc again. If the above-mentioned solution does not solve the problem, consult your nearest ALPINE dealer.

MP3 (When a CD changer compatible with MP3 is connected)

MP3 is not played back.

- Writing error occurred. The CD format is not compatible.
 - Make sure the CD has been written in a supported format. Refer to the instruction of the MP3 compatible CD changer, then rewrite in the format supported by this device.



Information

Indication for CD Player



HI TEMP

- Protective circuit is activated due to high temperature.
 - The indicator will disappear when the temperature returns to within operation range.
-

NO DISC



- No CD is inserted.
 - Insert a CD.
 - Although a disc is inserted, "NO DISC" is displayed and the unit does not start to play or eject the disc.
 - Remove the disc by following these steps:
 - 1) Press the  button.
The movable display will open.
 - 2) Press the  button again for at least 3 seconds while the movable display is open.
-

ERROR

- Mechanism error.
 - 1) Press the  button and eject the CD.
If not ejecting, consult your Alpine dealer.
 - 2) When the error indication remains after ejecting, press the  button again.
If the error indication still does not turn off after pressing the  button for a few times, consult your Alpine dealer.
-

NOTE

When the "ERROR" is displayed:

In case that the disc cannot be ejected by pressing the  button, press the RESET switch (refer to page 4) and press the  button again.

If not ejecting, consult your Alpine dealer.

Indication for CD Changer

HI TEMP

- Protective circuit is activated due to high temperature.
 - The indicator will disappear when the temperature returns to within operation range.
-

ERROR - 01

- Malfunction in the CD Changer.
 - Consult your Alpine dealer. Press the magazine eject button and pull out the magazine.
Check the indication. Insert the magazine again.
If the magazine cannot be pulled out, consult your Alpine dealer.
 - Magazine ejection not possible.
 - Press the magazine eject button. If the magazine does not eject, consult your Alpine dealer.
-

ERROR - 02

- A disc is left inside the CD Changer.
 - Press the Eject button to activate the eject function. When the CD Changer finishes the eject function, insert an empty CD magazine into the CD Changer to receive the disc left inside the CD Changer.
-

NO MAGZN

- No magazine is loaded into the CD Changer.
 - Insert a magazine.
-

NO DISC

- No indicated disc.
 - Choose another disc.
-

Specifications

FM TUNER SECTION

Tuning Range	87.5 – 108.0 MHz
Mono Usable Sensitivity	9.3 dBf (0.8 μ V/75 ohms)
50 dB Quieting Sensitivity	13.5 dBf (1.3 μ V/75 ohms)
Alternate Channel Selectivity	80 dB
Signal-to-Noise Ratio	80 dB
Stereo Separation	45 dB
Capture Ratio	2.0 dB

AM TUNER SECTION

Tuning Range	531 – 1,602 kHz
Sensitivity (IEC Standard)	22.5 μ V/27 dB

CD PLAYER SECTION

Frequency Response	5 – 20,000 Hz (\pm 1 dB)
Wow & Flutter (% WRMS)	Below measurable limits
Total Harmonic Distortion	0.008% (at 1 kHz)
Dynamic Range	95 dB (at 1 kHz)
Signal-to-Noise Ratio	105 dB
Channel Separation	85 dB (at 1 kHz)

GENERAL

Power Requirement	14.4 V DC (11–16 V allowable)
Maximum Power Output	50W \times 4
Maximum Pre-Output Voltage	2V/10k ohms
Maximum Subwoofer Output Voltage	4 V/10 k ohms
Bass	\pm 14 dB at 60Hz
Treble	\pm 14 dB at 10Hz
Weight	1.5 kg (3 lbs. 5 oz)

CHASSIS SIZE

Width	178 mm (7")
Height	50 mm (2")
Depth	155 mm (6-1/8")

NOSEPIECE SIZE

Width	170 mm (6-11/16")
Height	46 mm (1-13/16")
Depth	18 mm (11/16")

Due to continuous product improvement, specifications and design are subject to change without notice.

Installation and Connections

Before installing or connecting the unit, please read the following and pages 2 and 3 of this manual thoroughly for proper use.

Warning

MAKE THE CORRECT CONNECTIONS.

Failure to make the proper connections may result in fire or product damage.

USE ONLY IN CARS WITH A 12 VOLT NEGATIVE GROUND.

(Check with your dealer if you are not sure.) Failure to do so may result in fire, etc.

BEFORE WIRING, DISCONNECT THE CABLE FROM THE NEGATIVE BATTERY TERMINAL.

Failure to do so may result in electric shock or injury due to electrical shorts.

DO NOT SPLICE INTO ELECTRICAL CABLES.

Never cut away cable insulation to supply power to other equipment. Doing so will exceed the current carrying capacity of the wire and result in fire or electric shock.

DO NOT DAMAGE PIPE OR WIRING WHEN DRILLING HOLES.

When drilling holes in the chassis for installation, take precautions so as not to contact, damage or obstruct pipes, fuel lines, tanks or electrical wiring. Failure to take such precautions may result in fire.

DO NOT USE BOLTS OR NUTS IN THE BRAKE OR STEERING SYSTEMS TO MAKE GROUND CONNECTIONS.

Bolts or nuts used for the brake or steering systems (or any other safety-related system), or tanks should NEVER be used for installations or ground connections. Using such parts could disable control of the vehicle and cause fire etc.

KEEP SMALL OBJECTS SUCH AS BATTERIES OUT OF THE REACH OF CHILDREN.

Swallowing them may result in serious injury. If swallowed, consult a physician immediately.

DO NOT INSTALL IN LOCATIONS WHICH MIGHT HINDER VEHICLE OPERATION, SUCH AS THE STEERING WHEEL OR GEARSHIFT.

Doing so may obstruct forward vision or hamper movement etc. and results in serious accident.

Caution

HAVE THE WIRING AND INSTALLATION DONE BY EXPERTS.

The wiring and installation of this unit requires special technical skill and experience. To ensure safety, always contact the dealer where you purchased this product to have the work done.

USE SPECIFIED ACCESSORY PARTS AND INSTALL THEM SECURELY.

Be sure to use only the specified accessory parts. Use of other than designated parts may damage this unit internally or may not securely install the unit in place. This may cause parts to become loose resulting in hazards or product failure.

ARRANGE THE WIRING SO IT IS NOT CRIMPED OR PINCHED BY A SHARP METAL EDGE.

Route the cables and wiring away from moving parts (like the seat rails) or sharp or pointed edges. This will prevent crimping and damage to the wiring. If wiring passes through a hole in metal, use a rubber grommet to prevent the wire's insulation from being cut by the metal edge of the hole.

DO NOT INSTALL IN LOCATIONS WITH HIGH MOISTURE OR DUST.

Avoid installing the unit in locations with high incidence of moisture or dust. Moisture or dust that penetrates into this unit may result in product failure.

Precautions

- Be sure to disconnect the cable from the (-) battery post before installing your CDA-7892E. This will reduce any chance of damage to the unit in case of a short-circuit.
- Be sure to connect the color coded leads according to the diagram. Incorrect connections may cause the unit to malfunction or damage to the vehicle's electrical system.
- When making connections to the vehicle's electrical system, be aware of the factory installed components (e.g. on-board computer). Do not tap into these leads to provide power for this unit. When connecting the CDA-7892E to the fuse box, make sure the fuse for the intended circuit of the CDA-7892E has the appropriate amperage. Failure to do so may result in damage to the unit and/or the vehicle. When in doubt, consult your ALPINE dealer.
- The CDA-7892E uses female RCA-type jacks for connection to other units (e.g. amplifier) having RCA connectors. You may need an adaptor to connect other units. If so, please contact your authorized ALPINE dealer for assistance.
- Be sure to connect the speaker (-) leads to the speaker (-) terminal. Never connect left and right channel speaker cables to each other or to the vehicle body.

IMPORTANT

Please record the serial number of your unit in the space provided below and keep it as a permanent record. The serial number plate is located on the bottom of the unit.

SERIAL NUMBER: _____
INSTALLATION DATE: _____
INSTALLATION TECHNICIAN: _____
PLACE OF PURCHASE: _____

Installation

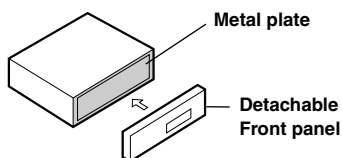

Caution

When you install this unit in your car, do not remove the Detachable Front Panel.
If the Detachable Front Panel is removed during installation, you might press too hard and warp the metal plate that holds it in place.

1

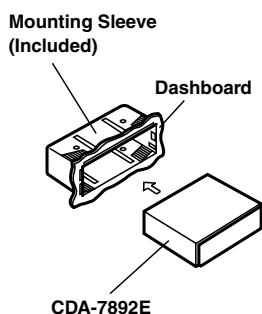

Slide the mounting sleeve into the dashboard.

2

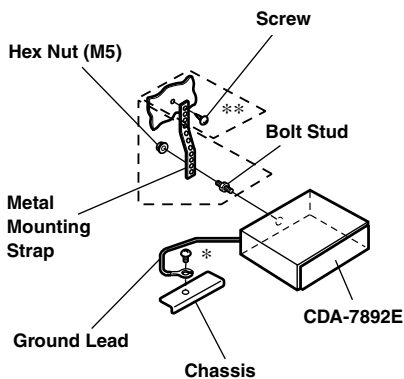

Reinforce the head unit with the metal mounting strap (not supplied). Secure the ground lead of the unit to a clean metal spot using a screw (*) already attached to the vehicle's chassis.

NOTE

For the screw marked **, use an appropriate screw for the chosen mounting location.

Connect each input lead coming from an amplifier or equalizer to the corresponding output lead coming from the left rear of the CDA-7892E. Connect all other leads of the CDA-7892E according to details described in the CONNECTIONS section.

3

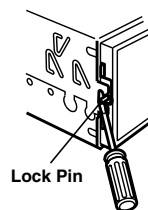

Slide the CDA-7892E into the dashboard. When the unit is in place, make sure the locking pins are fully seated in the down position. This can be done by pressing firmly in on the unit while pushing the locking pin down with a small screwdriver. This ensures that the unit is properly locked and will not accidentally come out from the dashboard. Install the Detachable Front Panel.

Removal

- 1 Remove the DETACHABLE FRONT PANEL.
- 2 Use a small screwdriver (or similar tool) to push the locking pins to the "up" position (see above drawing). As each pin is unlocked, gently pull out on the unit to make sure it does not re-lock before unlocking the second pin.
- 3 Pull the unit out, keeping it unlocked as you do so.

<JAPANESE CAR>

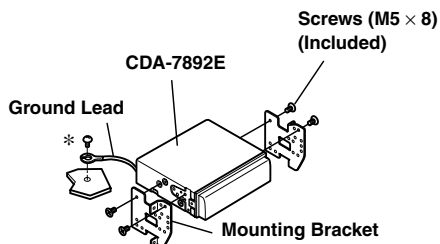
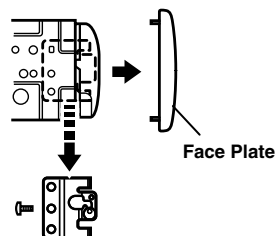

NOTE

Secure the ground lead of the unit to a clean metal spot using a screw (*) already attached to the vehicle's chassis.

Installation and Connections

Connections

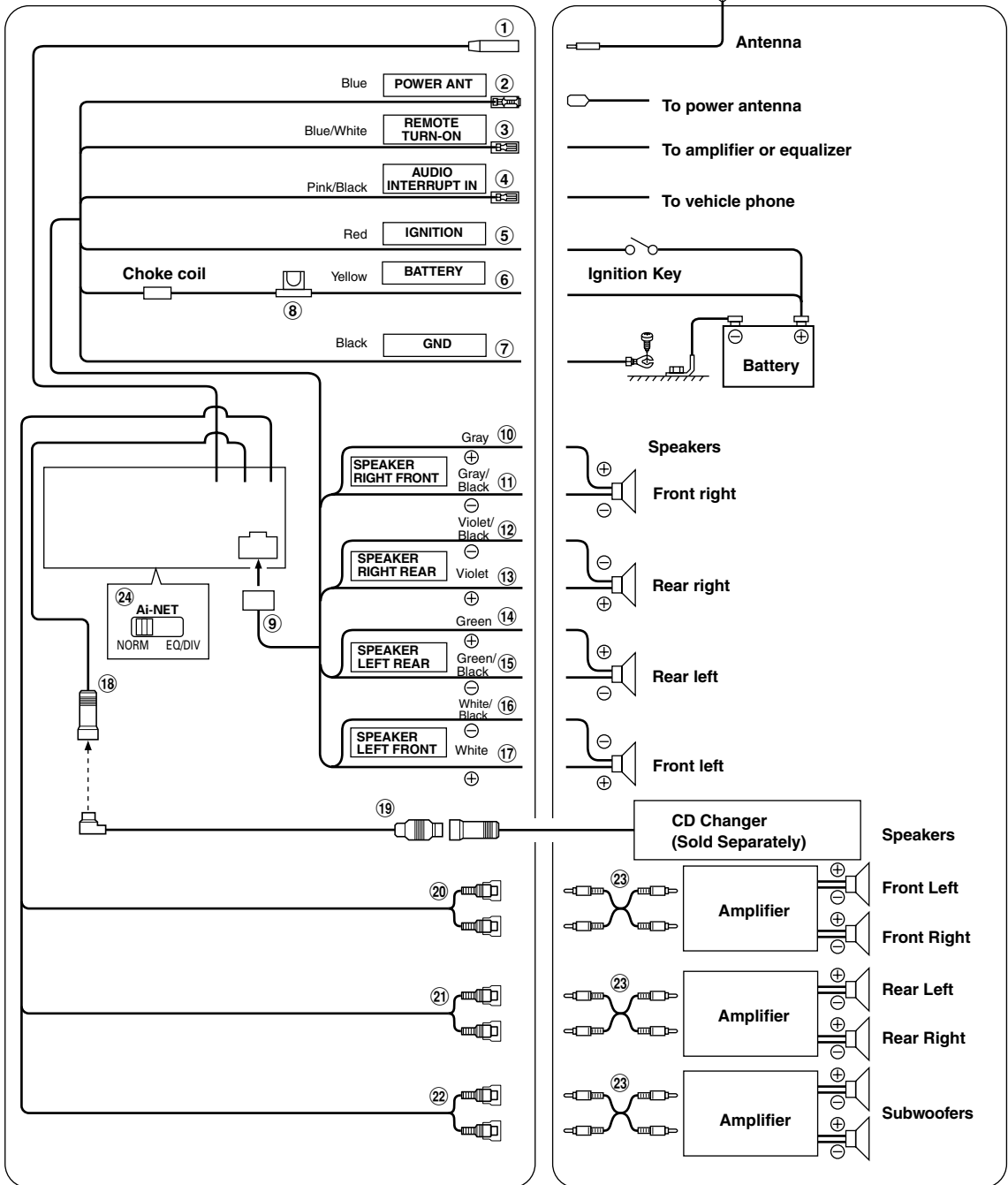

- ① Antenna Receptacle
- ② Power Antenna Lead (Blue)
Connect this lead to the +B terminal of your power antenna, if applicable.

NOTE

This lead should be used only for controlling the vehicle's power antenna. Do not use this lead to turn on an amplifier or a signal processor, etc.

- ③ Remote Turn-On Lead (Blue/White)
Connect this lead to the remote turn-on lead of your amplifier or signal processor.
- ④ Audio Interrupt In Lead (Pink/Black)
- ⑤ Switched Power Lead (Ignition) (Red)
Connect this lead to an open terminal on the vehicle's fuse box or another unused power source which provides (+)12V only when the ignition is turned on or in the accessory position.
- ⑥ Battery Lead (Yellow)
Connect this lead to the positive (+) post of the vehicle's battery.
- ⑦ Ground Lead (Black)
Connect this lead to a good chassis ground on the vehicle. Make sure the connection is made to bare metal and is securely fastened using the sheet metal screw provided.
- ⑧ Fuse Holder (15A)
- ⑨ Power Supply Connector
- ⑩ Right Front (+) Speaker Output Lead (Gray)
- ⑪ Right Front (-) Speaker Output Lead (Gray/Black)

- ⑫ Right Rear (-) Speaker Output Lead (Violet/Black)
- ⑬ Right Rear (+) Speaker Output Lead (Violet)
- ⑭ Left Rear (+) Speaker Output Lead (Green)
- ⑮ Left Rear (-) Speaker Output Lead (Green/Black)
- ⑯ Left Front (-) Speaker Output Lead (White/Black)
- ⑰ Left Front (+) Speaker Output Lead (White)

- ⑱ Ai-NET Connector
Connect this to the output or input connector of other product (CD Changer, Equalizer, etc.) equipped with Ai-NET.

NOTE

You can input TV/video sound by connecting an optional Ai-NET/RCA Interface cable (KCA-121B) to this component.

- ⑲ Ai-NET Cable (Included with CD Changer)
- ⑳ Front Output RCA Connectors
- ㉑ Rear Output RCA Connectors
RED is right and WHITE is left.
- ㉒ Subwoofer RCA Connectors
RED is right and WHITE is left.
- ㉓ RCA Extension Cable (Sold Separately)
- ㉔ System Switch
When connecting a processor or divider using Ai-NET, place this switch in the EQ/DIV position. When no device is connected, leave the switch in the NORM position.

NOTE

Be sure to turn the power off to the unit before changing the switch position.

To prevent external noise from entering the audio system.

- Locate the unit and route the leads at least 10 cm away from the car harness.
- Keep the battery power leads as far away from other leads as possible.
- Connect the ground lead securely to a bare metal spot (remove any paint, dirt or grease if necessary) of the car chassis.
- If you add an optional noise suppressor, connect it as far away from the unit as possible. Your Alpine dealer carries various noise suppressors, contact them for further information.
- Your Alpine dealer knows best about noise prevention measures so consult your dealer for further information.

